

**Lake Sunapee Cruising Fleet**  
**Sailing Instructions**  
**2023 Rev 2 05/27/23 dh gm**



## 1. Rules

All races will be governed by The Racing Rules of Sailing (US Sailing) published by the United States Sailing Association in their 2021-2024 edition, and by these Sailing Instructions. The Racing Rules of Sailing in PDF format is also available for downloading from the United States Sailing Association Web Site.

### [Racing Rules of Sailing 2021 - 2024](#)

## 2. Entries

Eligible boats may be entered by completing registration with the Lake Sunapee Cruising Fleet and provide a copy of a certificate of insurance with a minimum \$300,000 liability coverage either homeowners policy or specific boat policy. Our fleet is open to monohull cruising boats.

## 3. Notices to Competitors

Notices to competitors will be transmitted by e-mail 3 days prior to becoming effective.

## 4. Schedule of Races

Races will be conducted according to the 2023 Race Schedule listed on the LSCF Web Site. [www.lscf.us](http://www.lscf.us) The schedule may be modified with proper notice (minimum 3 days email). Dates of make-up races are also listed on the LSCF Web Site. Additionally, based on the number of races canceled the fleet may be asked to sail a Thursday night make-up race. Skippers will be notified by email minimum of 3 days in advance.

## 5. Weather Cancelations

The fleet will use a weather app, designated at the first fleet meeting, for weather related decisions regarding racing safety. This applies to wind, rain, storms, and lightning that might impact our ability to provide a safe racecourse.

We will be looking at the weather forecasts for the period 4:00 PM until 7:00 PM on Wednesdays and from 12:00 PM until 3:00 PM on Sundays. A forecast of thunderstorms during those time windows will result in cancellation. We also monitor wind speed and if, during those time periods, the sustained winds are 15mph or greater, then the race will be canceled. If the sustained winds are 3mph or less, then the race will be canceled.

We utilize text messaging to notify the fleet about canceled races on Wednesdays on or before 3:30 pm and 11:00 AM for Sunday race cancelations. After the initial notification time has

elapsed, the weather cancelation determination transfers to the Committee Boat on the water and they will notify the fleet accordingly using horns, flags, and VHF radio announcements.

## 6. Classes

There are two classes of racing - Division I Class and Division II Cruiser Class. Boats are in one of these classes based on the following:

- Boats of similar design entered in the Division I Class and have PHRF cruising handicap ratings of 188 and below and may elect to fly a spinnaker or not.

For a boat to be eligible, it must have a performance handicap certificate obtained from PHRF-NE.

If a skipper wants to fly a spinnaker, under PHRF you must declare so before the start of a race series (A, B, C) and you will race in that series using the PHRF racing handicap. Flying a spinnaker triggers the PHRF racing rating while no spinnaker will use the PHRF cruising rating. When Sonars only are racing they will be scored by Place.

- Boats entered in the Division II Cruiser Class Keel, and Centerboard have PHRF cruising ratings of 189 or greater. The Keelboats are scored using PHRF Time on Distance. The Centerboard boats will be scored by Place. Spinnakers or other free-flying sails are not allowed in the Division II Cruiser Class.
- For a boat to be eligible, it must have a performance handicap certificate obtained from PHRF-NE.

There is a "Family Friendly Exemption" for Series C (Sundays) only that allows a Division I boat (PHRF cruising rating of 189 or below) sailing with 2 or more kids (14 years or younger as of 9/1) to race and be scored in the Division II Cruiser Class (not flying a spinnaker).

## 7. Communications

All boats in all classes should carry a functioning VHF radio. Each boat shall monitor VHF Channel 72. The Race Committee will utilize VHF Channel 72 and will use that channel for fleet communications subject to the provisions in other sections of these Sailing Instructions. The Race Committee will monitor VHF Channel 72 for emergency transmissions.

Radio communications by the Race Committee are informational and a matter of courtesy only. Only the Race Committee may request redress on an issue arising from radio or other courtesy communications.

## 8. Racing Area

The racing area will be the main body of Lake Sunapee except for the End-to-End races designated in the racing schedule. The exact location of the racecourses will vary with wind conditions.

## 9. The Courses

All races except those designated as Special Races will either be Windward – Leeward or Triangular in shape as follows:

Course “0” (Triangle + Windward + Leeward + Windward) – (Olympic)

Course “1” (Triangle + Windward + Leeward) – (Gold Cup)

Course “2” (Triangle + Windward)

Course “3” (Windward – Leeward (with optional Offsetting mark))

Course “4” (Windward – Leeward – Windward – Leeward (with optional Offsetting mark))

Course “LA2” (Start – 1 – 1a – 2s/2p – 1 – 1a - Finish) - 2 *windward legs*

Course “LA3” (Start – 1 – 1a – 2s/2p – 1 – 1a – 2s/2p – 1 – 1a - Finish) – 3 *windward legs*

Course “LA4” (Start – 1 – 1a – 2s/2p – 1 – 1a – 2s/2p – 1 – 1a – 2s/2p – 1 – 1a - Finish) 4 *windward legs*

Course “WA2” (Start – 1 – 1a – 2s/2p – Finish) – 2 *windward legs*

Course “WA3” (Start – 1 – 1a – 2s/2p – 1 – 1a – 2s/2p - Finish) - 3 *windward legs*

Course “WA4” (Start – 1 – 1a – 2s/2p – 1 – 1a – 2s/2p – 1 – 1a – 2s/2p – Finish) - 4 *windward legs*

Course “WE” (Start – 1 – Leeward – Finish)

See diagrams attached at the end of this Sailing Instructions document.

Courses 0,1,2,3,4 will be indicated by the numerical flag system (see course diagrams for associated numerical flag). LA and WA courses will be indicated by a flag with White background with LA or WA in black letters over a white flag with the numbers 2, 3, or 4, and possibly by a white board system located on the RC boat. WE course will be indicated by a flag with White background with WE in black letters.

If there is any confusion the flag is the determining factor as to which course will be sailed. The number board is a courtesy aid. Due to space constraints on the white board, LA or WA courses will be indicated by the LA WA course number only 2, 3, or 4 in combination with the LA WA flag.

## 10. Marks

Mark 1 will be an orange mark. Marks 2, 3, optional offset mark, & LA/WA gate 2P/2S will be yellow – (reach, leeward, optional offset, & LA/WA gate). Start and finish will be between the start/finish orange buoy and the committee boat orange flag.

## 11. The Start

Wednesday evening's races will be scheduled to start with the following start sequence for Division I and Division II boats.

The Starting procedures as stated in the US Sailing Rules of Sailing 2021-2024 will be followed.

### Start Procedure

#### *Anticipated* Start Warning Signal

Weekdays	5:35 PM
Sundays	12:50 PM

RC Boat will DISPLAY an ORANGE LINE FLAG while on station.

All start and finish calls will be between the ORANGE Flag on the committee boat and the start/finish mark (PIN)

- One minute prior to the start sequence, three sound signals – pending start sequence.
- Five minutes to start Division Flag goes up with sound – Warning signal, (Yellow for Division 1, White for Division 2).
- Four minutes to start the preparatory flag goes up with sound – Preparatory Signal.
- One minute to start the preparatory flag comes down with sound – 1 minute signal.
- Start – Division flag (Yellow or White) comes down with sound signal!

If a boat is over early the individual recall flag – the X Flag (White with Blue Cross) is put up at start accompanied by one sound signal. RC will ATTEMPT to notify with a hail and/or on VHF Channel 72 to boats over but it is the responsibility of yachts to know if they are over and restart.

RC may raise “AP” postponement flag at any time prior to start along with two sound signals.

RC may at start raise “First Repeater” (General Recall – Yellow Pennant w/Blue Border) with Sound signal. All boats return for race restart.

Whenever “AP” or “First Repeater” is lowered with sound signal it is the warning that the start sequence will start in one minute.

SOUND SIGNALS (Horn/Whistle) are a courtesy, only the visual FLAG) signals count!

#### Div 2 Start:

- One minute after Division 1 has started, with all boats clear, there will be three sound signals – pending start sequence for Div 2.
- In one minute the Start Sequence for Div. 2 will begin. (Same as for Div. 1) 5 minute, 4 minute, 1 minute, START.

- If boats of Division 1 are over and not cleared (restarted properly) i.e. individual recall, 4 minutes after Division 1 start signal there will be three sound signals – pending start sequence
- In one minute Start Sequence for Div. 2 will begin. (Same as for Div. 1) 5 minute, 4 minute, 1 minute, START.

The I-Flag Rule (RRS 30.1) is in effect for all races. The I-Flag Rule requires all boats that are on the course side of the starting line or of its extensions during the last minute before the starting signal to sail from the course side across the extension to the prestart side before starting.

All boats need to check in with the Committee Boat on arrival in the starting area to make sure that the Committee Boat knows that boat will be racing. Check in should occur before the warning signal whenever possible so as not to interfere with the starting sequence.

It should be noted that all times are approximate and that the one minute 3 sound signals - 'pending start sequence' will be given when the race committee is ready. Each flag will be lowered one minute before the next flag is raised and the horn sounded. The start is officially based on the visual flag observance. Sound signals are provided as a courtesy only. All timing should be off of flag raising and lowering.

Sunday races warning is at approximately 12:50 PM including End-To-End races. Regular Sunday series are 2 races back to back. Second race sequence same as above.

Postponement of a race is flying an "AP" flag and two sound signals. The signal to abandon a race is raising the "N" Flag and 3 sound signals.

### Postponement Signals

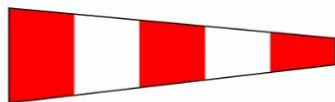

**AP** Races not started are *postponed*. The warning signal will be made 1 minute after removal unless at that time the race is *postponed* again or *abandoned*.

### Abandonment Signals

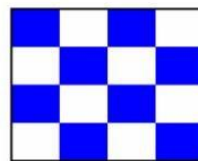

**N** All races that have started are *abandoned*. Return to the starting area. The warning signal will be made 1 minute after removal unless at that time the race is *abandoned*

\*To see flags go to [LSCF.US](http://LSCF.US) web site under rules. Click on the Racing Rules of Sailing link and scroll down to see the colored pictures (exception are class flags) they are as described above.

## 12. Recalls

Individual recalls will be signaled in accordance with RRS racing rule 29.1 – ( X flag ,1 sound signal ). When individual recalls are signaled, as a courtesy, the RC will endeavor to announce the names and/or sail numbers of OCS boats by hailing and/or on VHF Channel 72. Failure of the race committee to hail or failure of a boat to hear the hail of its sail number shall not relieve the boat of its obligation to start correctly.

If over early, individual boats must go around either end of the starting line, cross its extension and restart from the prestart side.

A general recall of all boats will be signaled in accordance with RRS racing rule 29.2 or by hail from the committee boat (2 short horn sounds, first substitute flag).

### Recall Signals

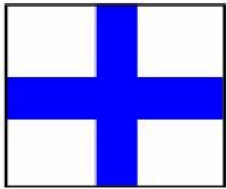

**X** Individual recall.

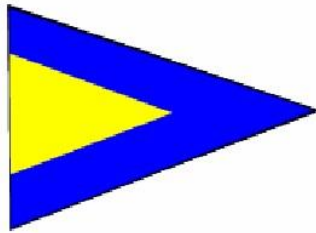

**First Substitute** General recall.  
The warning signal will be made  
1 minute after removal.

## 13. Change of Course After the Start

### Change of Course After the Start

A change of course after the start will be signaled (2 short horn sounds, S flag) before the leading boat has begun the leg, although the new mark may not then be in position. Any mark to be rounded after the initial course change rounding will maintain the original course configuration. If there is a subsequent change of course and a new mark is replaced, it will be replaced with an original mark with a black band.

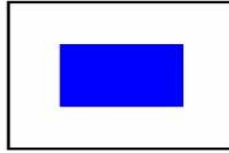
**Shortened Course**

**S** The course has been shortened. Rule 32.2 is in effect.

**14. The Finish**

The finishing line will be between a staff displaying an ORANGE flag on the race committee boat and the port end finishing mark (PIN). The ORANGE flag replaces the new BLUE (*finish*) flag in the RRS 2021-2024 (*Other Signals*).

**15. Time Limit**

Except for end-to-end races, the time limit for the first leg of the race is 1 hour and for the entire race is 3 hours.

**16. Protest**

During the race skippers are expected to follow the rules and should talk about who has rights on the water before rules are broken (Experienced skippers should help less experienced skippers to understand the rules.) A skipper who commits a foul should immediately do the appropriate penalty turns to be exonerated before continuing to race.

If rules are broken, protest hails should occur immediately after the infraction occurs and a protest flag shall be displayed at the first reasonable opportunity and remain displayed until the boat is no longer racing unless the protested boat has been exonerated by doing the appropriate penalty turns (2 penalty turns for most infractions, 1 penalty turn for hitting a mark).

If the skippers involved do not agree on the infraction, an official protest should be lodged in accordance with RRS Racing rules, Part 5. Protests shall be in writing (simple written protest statement explaining the reason for protesting) and should be submitted to a Rules Committee member as soon as practical after the race and no later than 1 day after the race. Immediately after the race, notify the Rules Committee Chairperson (see website for contact information) by phone, text or email that a protest is being prepared. Also let the Committee Boat know at the end of the race that you will be filing a protest so that this information is included with the race results.

Protest committee is made up of three Rules Committee members and/or others as deemed necessary by the Rules Committee.

Note: Questions relating to the racing rules should be directed to the Rules Committee.

## 17. Scoring

Scoring of races for all of the 2023 Series will be as follows:

### **Division I**

Time-on-Distance (ToD) based upon PHRF-NE performance handicaps, if only Sonars are competing in a race, the race will be scored by place.

### **Division II – K ( Keelboats )**

Time-on-Distance (ToD) based upon PHRF-NE performance handicaps.

### **Division II – C ( Centerboards )**

One Design fleet scored by place

The Low Point Scoring System will be utilized, the winners being determined by the lowest average scores for each of the three series and the lowest overall score total for the three series. A minimum of two boats in a given class must race to qualify for inclusion in the Series Scoring. Two or more series races will constitute a series. Separate placing will be awarded for Division I, Division II Keel class and Division II Centerboard class.

### **Drop Profile for A & B series, 7 races total – 0,0,0,0,1,2,2**

Until the fifth race is completed there are no throw outs. After the fifth race is completed, one race will be thrown out. When the sixth race is completed, two races will be thrown out. Two throw outs is the maximum for A & B series.

### **Drop Profile for C series, 9 races total – 0,0,0,0,0,0,1,2,3 (2 races each race date)**

Until the seventh race is completed there are no throw outs. After the seventh race is completed, one race will be thrown out. When the eighth race is completed, two races will be thrown out. When the ninth race is completed, three races will be thrown out.

Three throw outs is the maximum for C series.

Boats will receive the average score for the series when serving committee boat duty.

0

## **Excerpts from Appendix A SCORING RRS 2021 - 2024**

**A5.3 does apply for Lake Sunapee Cruising Fleet races. Note: A5.3 describes the way we have been scoring prior to RRS 2021 – 2024.**



**A5.3 If the notice of race or sailing instructions state that rule A5.3 will apply, rule A5.2 is changed so that a boat that came to the starting area but did not start, did not sail the course, did not finish, retired or was disqualified shall be scored points for the finishing place one more than the number of boats that came to the starting area, and a boat that did not come to the starting area shall be scored points for the finishing place one more than the number of boats entered in the series.**

Race ties are resolved using RRS 2021-2024 Appendix A, A7-A8.2 as follows:

## **A7 RACE TIES**

If boats are tied at the finishing line or if a handicap or rating system is used and boats have equal corrected times, the points for the place for which the boats have tied and for the place(s) immediately below shall be added together and divided equally. Boats tied for a race prize shall share it or be given equal prizes.

## **A8 SERIES TIES**

A8.1 If there is a series-score tie between two or more boats, each boat's race scores shall be listed in order of best to worst, and at the first point(s) where there is a difference the tie shall be broken in favor of the boat(s) with the best score(s). No excluded scores shall be used.

A8.2 If a tie remains between two or more boats, they shall be ranked in order of their scores in the last race. Any remaining ties shall be broken by using the tied boats' scores in the next-to-last race and so on until all ties are broken. These scores shall be used even if some of them are excluded scores.

Note - Fleet Championship Tie – Series A, B, & C with their respective drops treated as one series and A8.1, 8.2 applied.

## **18. Government Marks**

All government marks and navigation aids within the racing area must be observed.

## **19. Responsibility**

The decision of whether to race or continue to race in adverse weather conditions or with faulty equipment, or to wear personal flotation devices, lies with the skipper of each yacht. The Lake Sunapee Cruising Fleet is not responsible for accidents or injuries to yachts or persons suffered in any way from any cause during or related to racing. Each competing boat MUST

have an operable motor with sufficient fuel or battery to get to shore. It is suggested that each skipper discuss his/her liability with their respective legal counsel and their insurance professional.

# Course 0

Triangle + Windward + Leeward + Windward (Olympic)

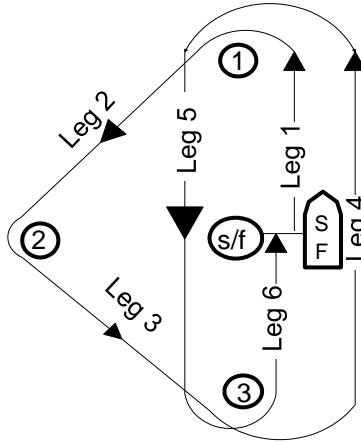

# Course 1

Triangle + Windward + Leeward (Gold Cup)

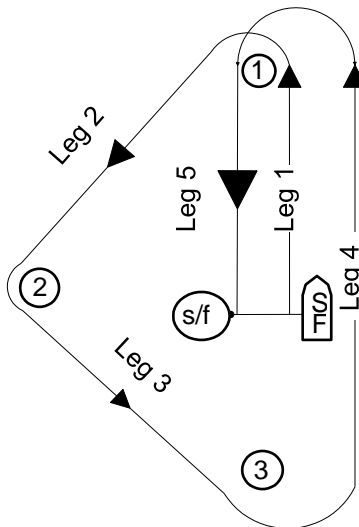

# Course 2

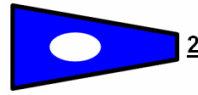

## Triangle + Windward, 4 legs total

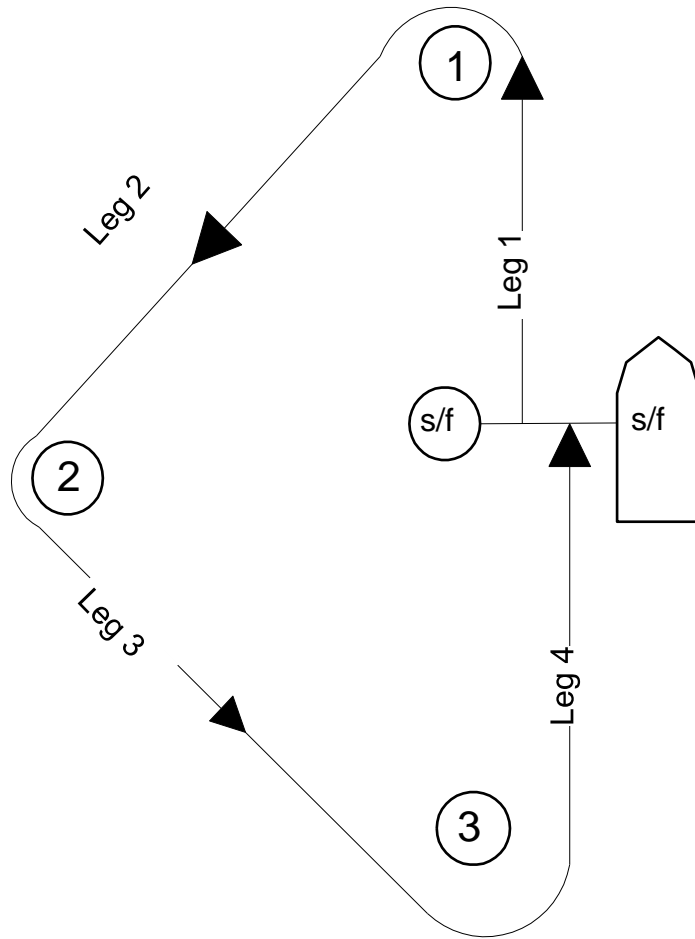

# Course 3

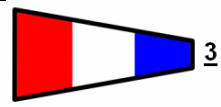

## Windward-Leeward, 3 legs (optional offsetting mark)

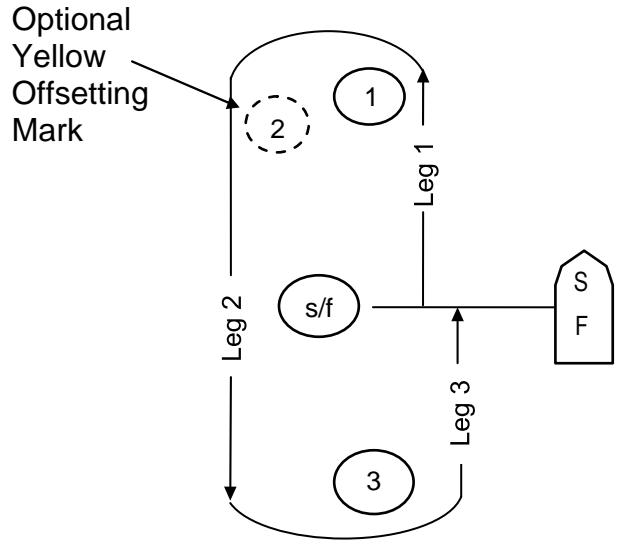

Or

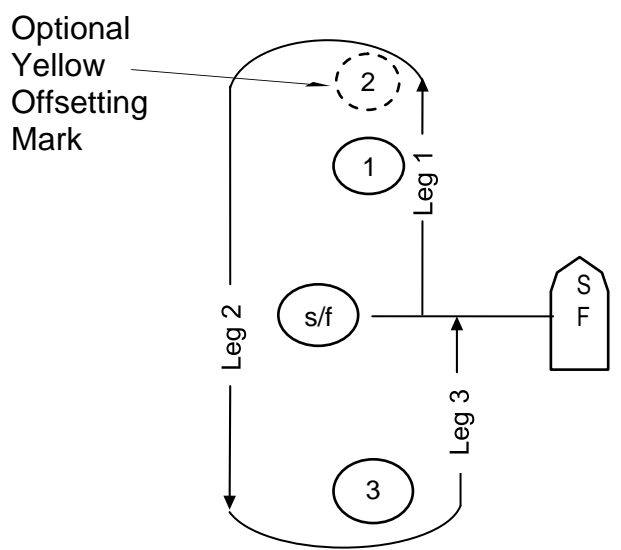

# Course 4 4

## Windward-Leeward, Windward-Leeward 6 legs (optional offsetting mark)

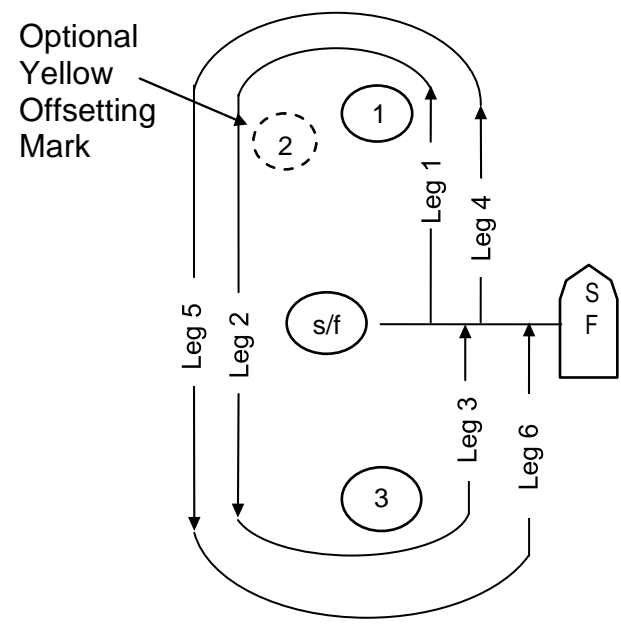

Or

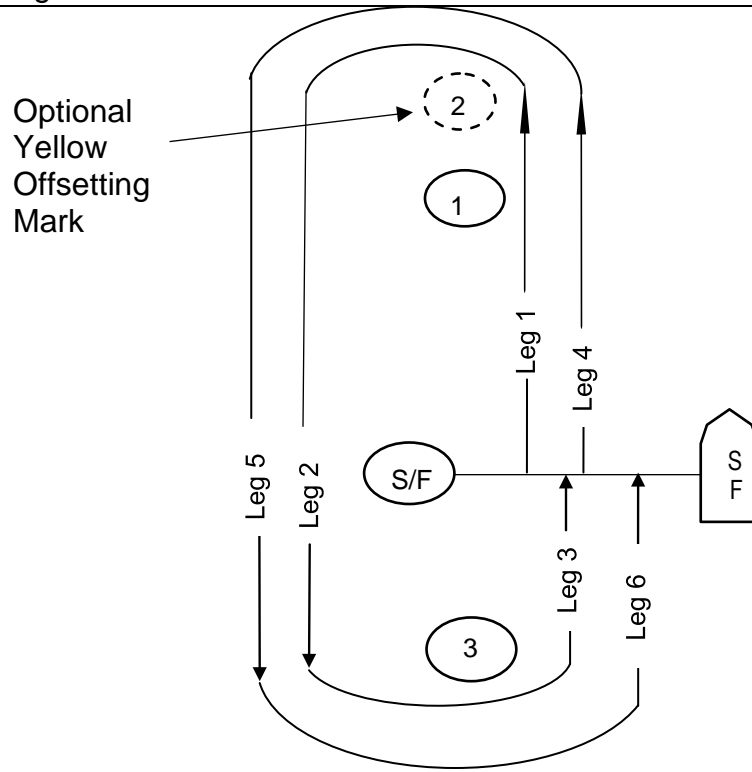

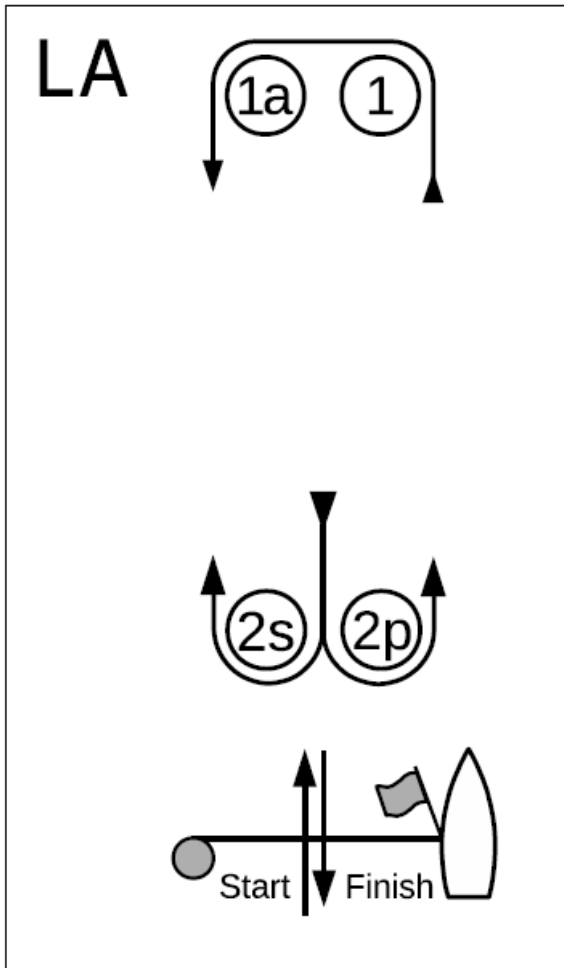

Course LA – Windward/Leeward with Offset Mark, Leeward Finish	
Signal	Mark Rounding Order
LA2	Start – 1 – 1a – 2s/2p – 1 – 1a – Finish
LA3	Start – 1 – 1a – 2s/2p – 1 – 1a – 2s/2p – 1 – 1a – Finish
LA4	Start – 1 – 1a – 2s/2p – 1 – 1a – 2s/2p – 1 – 1a – 2s/2p – 1 – 1a – Finish



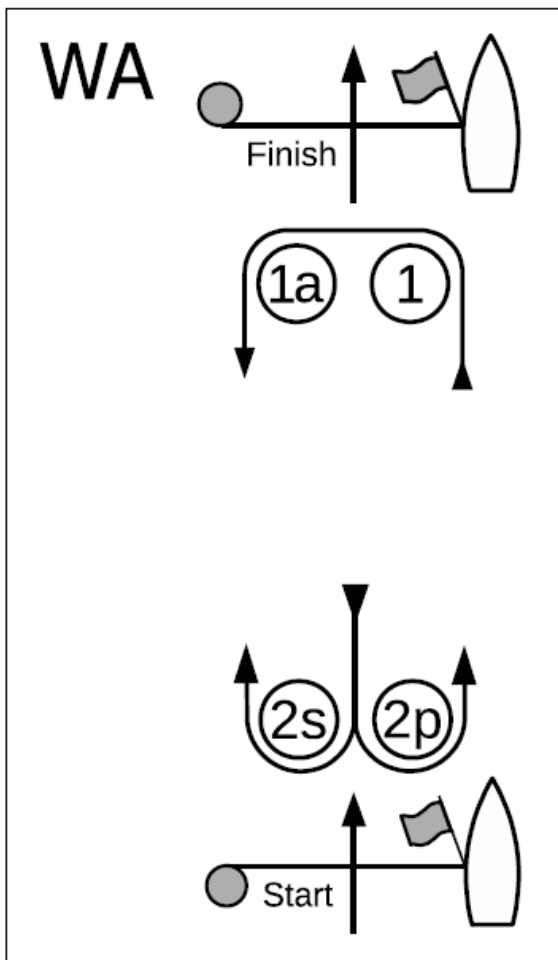

Course WA – Windward/Leeward with Offset Mark, Windward Finish	
<i>Signal</i>	<i>Mark Rounding Order</i>
WA2	Start – 1 – 1a – 2s/2p – Finish
WA3	Start – 1 – 1a – 2s/2p – 1 – 1a – 2s/2p – Finish
WA4	Start – 1 – 1a – 2s/2p – 1 – 1a – 2s/2p – 1 – 1a – 2s/2p – Finish

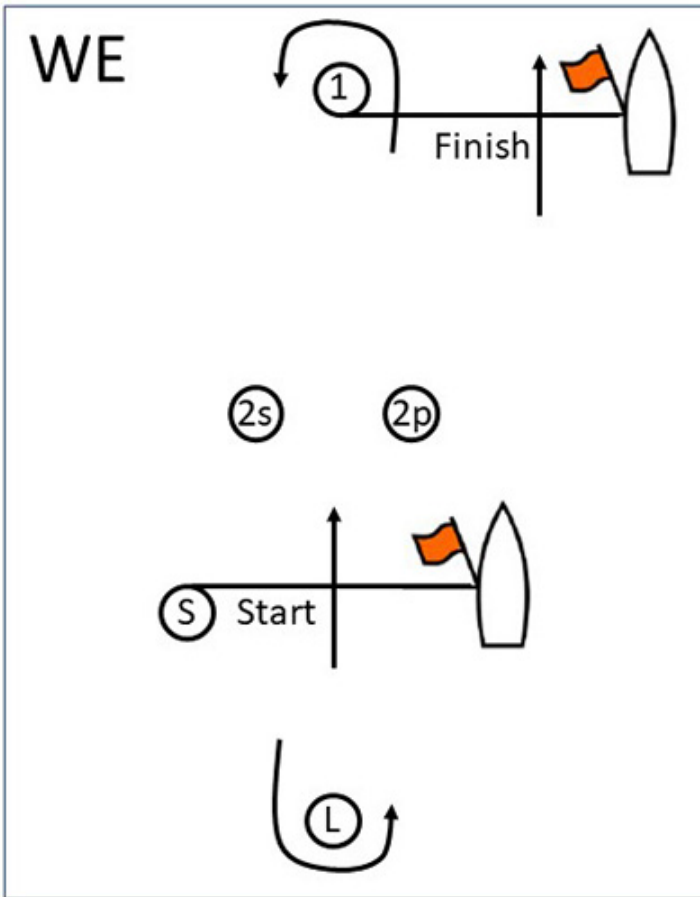

Course WE – Windward with Extended Leeward mark	
Signal	Mark Rounding Order
WE	Start – 1 – L – Finish